



COMMERCIAL LAUNDRY SYSTEM

The Best Solution Commercial Laundry

- Stronger
- Smarter
- Healthier
- More Efficient

What's New in Titan Max?

Users get more done in less time with up to 150L Tub, enhanced speed and LG's Exclusive stackable design



Faster

LG's Gyro Balancing Sensor precisely detects the tub movement to activate the most proper algorithm for washing cycle, ensure it finish within 36mins.



Smarter

Now LG Smart Solution available! Maximize your profit in a smartest way by monitoring your laundromat operations remotely. LG's Remote Monitoring App makes it easier than ever



Healthier

Always keep your washers clean with LG Hygiene Care System Now you can sanitize your washers before, during, and after each load.



Stronger

LG's professional grade parts are built to last repeated use, meaning less repairs and more profits. In addition to our powerful Inverter Direct Drive Motor, new Gyro Balancing System technology minimize friction and vibration.

Built for More, Built for Speed

Do more in less time with the high-capacity stackables.

15kg

Bigger Capacity

NEW
Stackable



Trusted Worldwide to Help Businesses Succeed

The LG commercial laundry solution can be perfectly suited in any business environment. We are "Stronger, Smarter, Healthier, More efficient"

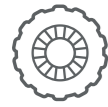

Stronger



Smarter



Healthier



More Efficient



GYRO BALANCING SYSTEM

Designed to Last

LG's professional grade parts are built to last repeated use, meaning less repairs and more profits.

*Noise levels may vary based on machine settings & other factors.



LG's Gyro Balancing Sensor precisely detects the tub movement to activate the most proper algorithm for washing cycle, ensure it finish within 36 mins.



Dual Spin Algorithm

Dual Spin Algorithm has 2 types of modes which are normal sensing mode and hyper sensing mode. You can choose optimal spin algorithm depends on installation site. If the short time is important factor such as laundromat, you can choose normal sensing mode. And, if the low vibration or noise is crucial factor such as apartment and dormitory, you can select hyper sensing mode.



New Quattro Damping System

Improved damping system controls optimized the tub movement



SMARTER CONVENIENCE

Smart Control, Smart Business

LG Smart Solution is a Cloud service that connects businesses and machines to everyone from business owners to customers.

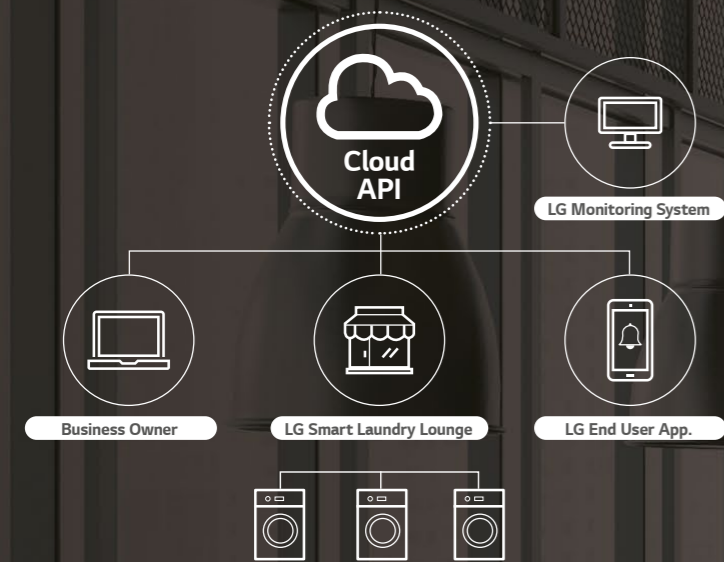

LG Monitoring System



Smart Control, Smart Business



LG End User App



3+1 HYGIENE CARE LAUNDRY SYSTEM

WHY? We Provide Hygiene Solution with 3+1 Steps

Sanitize your washers before, during and after each load.



Step 1

Clean Tub Cycle

3-minute Clean before Use



Step 2

Hygiene Cycle

99.9% Hygienically clean

* Customer pays extra charge for this cycle



Step 3

Intensive Tub Cleaning Cycle

leaves the Tub squeaky clean

*Tub cleaning is recommended to perform by regular basis



Step 4

Drying

Sterilize to Last Clean

WASHER



DRYER



99.9% Germs Removed

*Users can remove 99.9% of the germs on fabrics and clothing when running the Hygiene Cycle for washing and drying.

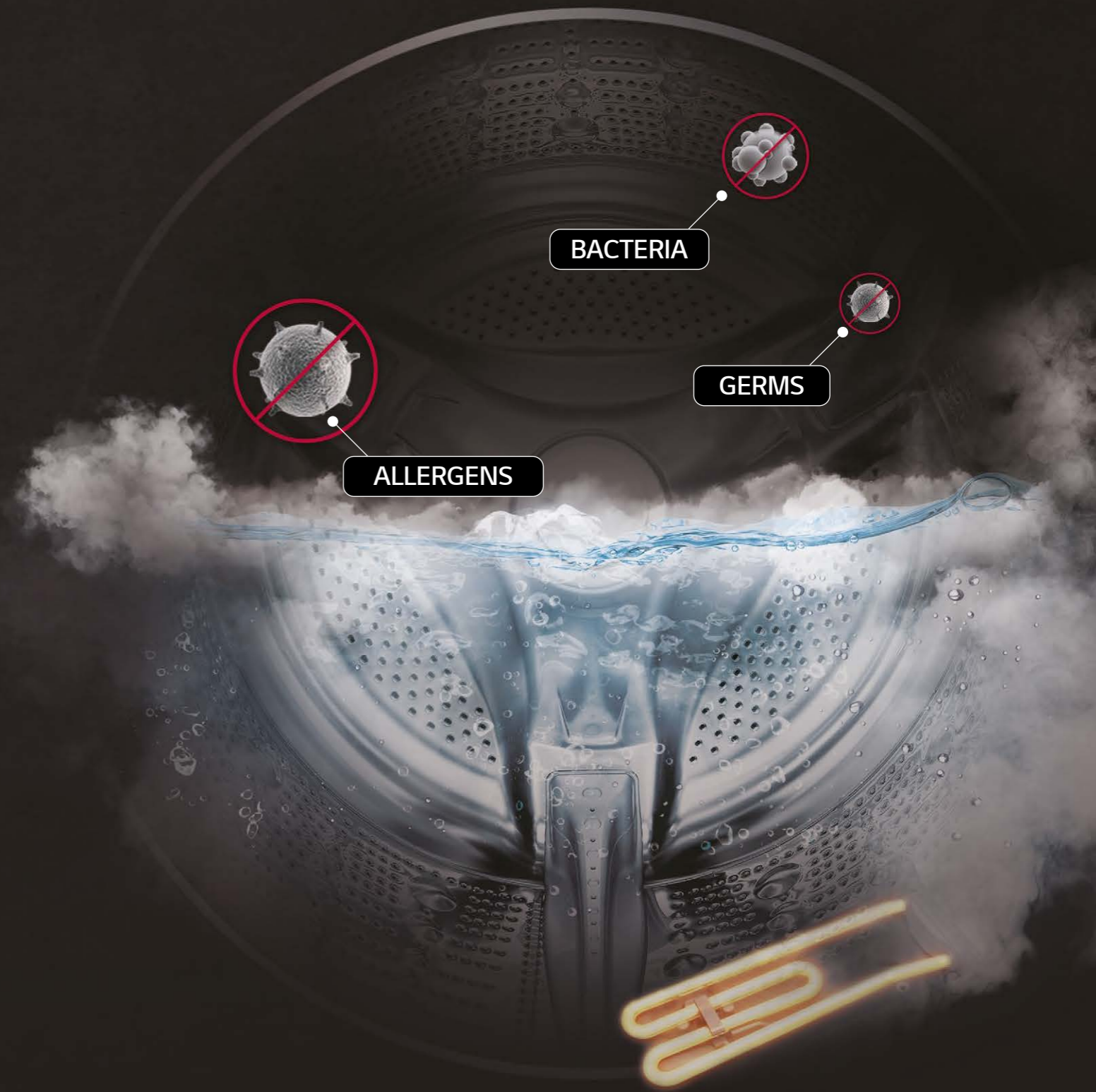

What is Important for Success of Laundromat ?



See Your Profits Rise with LG Hygiene & Saving System

“ Now, Customer Have Safer Access to Laundry. ”

The Hygiene Clean System ensures your washers are clean before, during and after each use. There are three cycles available: first, the Clean Tub Cycle that takes just three minutes to clean the tub before use; next, the Hygiene Cycle which sanitizes your fabrics; and last, an Intensive Tub Cleaning Cycle that can be run once the load is done.



| 3+1 Hygiene Care Laundry System |

A sanitizing wash and dry and everything in between.

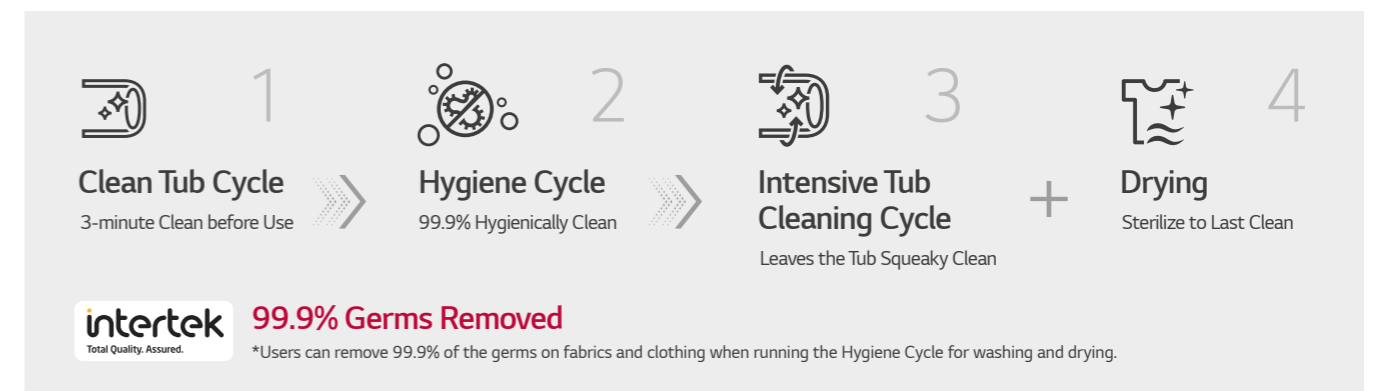

“ Discover opportunities to drive profit with LG Saving System. ”

| Saving System |

Run your laundromat more efficiently by saving water and energy, thus improving your bottom line.



Are you looking for a quiet and sturdy machine ?



Built Strong, to Last Long

“ LG’s professional grade parts are built to last repeated use, meaning less repairs and more profits.”

The LG Inverter Direct Drive Professional Motor™ eliminated the traditional belt and pulley system, which means less moving parts. Less moving parts means less wear and tear, making our LG washing machines much more durable. To ensure long lasting performance, the shaft that connects the drum and motors gets a heat treatment, which protects against wear and tear from repeated use. LG dryers have a Tempered Glass door, making them less susceptible to breaking, and you can see through the door to check the status of your load.

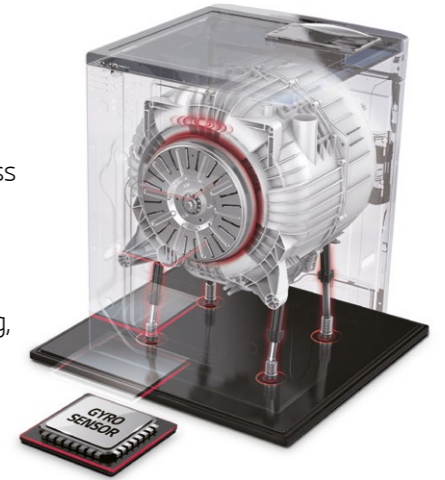

| Inverter Direct Drive™ |

Excellent Durability & Reliability

Unlike the traditional belt and pulley, the LG Commercial Laundry drum is directly attached to the motor providing superior durability and reliability. Less parts equal less repairs.

<p>Conventional Motor</p> <ul style="list-style-type: none"> • Belt & Pulley 	VS	<p>Inverter Direct Drive™</p> <ul style="list-style-type: none"> • No Belt & Pulley • Less Noise & Vibration • Powerful Washing Performance
--	----	---

| Gyro Balancing System |

Low Noise, Less Vibration

LG Gyro Balancing System provides optimized performance through advanced algorithm, which allows for errorless spin entry and on time cycle completion.

<p>Gyro Sensing + Quattro Damping</p> <p>LG Gyro Balance System provides optimized performance through advanced algorithm.</p>	
---	--

Are You Looking for the Smartest Way to Run Business?



Yield more Productivity and Profits with LG Smart Solutions

“ Owners and users can manage their laundry productivity remotely with the LG Remote Laundry App.”

Both owners and users can manage their laundry productivity remotely with the LG Remote Laundry App. Owners can monitor revenue, set up new machines, manage error messages and get alerts when there is a problem in the laundromat. Users can also get a notice sent to the app when machines are available, so there is no need to wait in the laundry room for vacant machines. When the laundry is about to be done, the user can get an alert to head back to the laundromat.

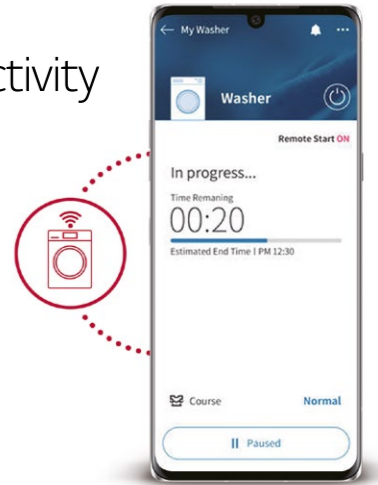

! LG Remote Laundry Solution !

Work Freely and Remotely

Streamline Maintenance can monitor conditions and detect errors anytime and anywhere; adjust settings and control individual locations and even specific machines.



Preferred by Customers

Now with the ability to check laundry status with their smartphone, customers are free to the gym or shop while they wait for their laundry to finish.

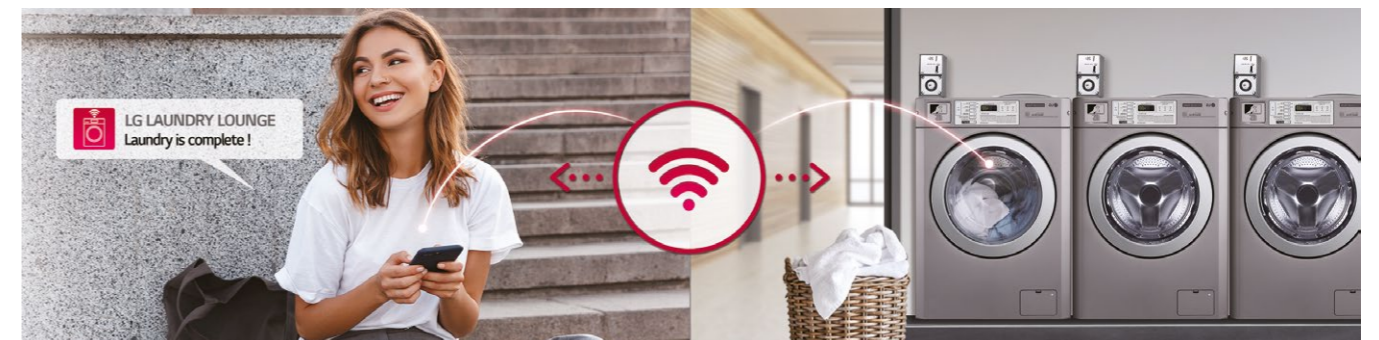

Main Features Function

Stronger

Premium Powder Coating

Our powder coated finish creates the same durability as it does when painting a car. It is sure to last long and provide an easy to clean exterior.



Inverter Direct Drive™

Unlike the traditional belt and pulley system, the LG commercial laundry drum is directly attached to the motor providing superior durability and reliability. Fewer parts equals fewer repairs.



Gyro Balancing System

Gyro Balancing System makes longer lifespan to detect vibration and minimize friction damage.

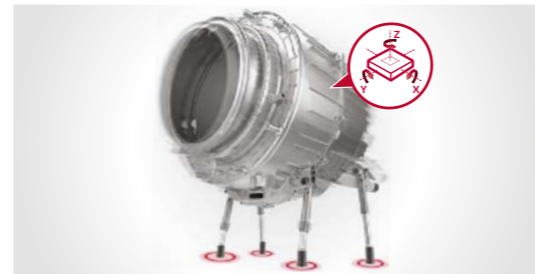

Healthier

Hygiene Care System

The Hygiene Cycle System ensures your washers are clean before, during and after each wash.



Auto Dosing System

Simple to connect automatic detergent/chemical injection system.
*Autodosing Pump (Purchase Separately)



More Efficient

Space Saving

The small cabinet size with bigger washing capacity and stackable design allows more customers and more machines in limited space.



10° Tilted Drum

LG's commercial washer tub is tilted 10°. It enables the washer to have higher water level compared to competitors. This allows us to use less water while not sacrificing superior wash performance.



Atomizing & Twin Spray

Twin Spray rinses your clothes non-stop while spinning, resulting in a speedier wash and higher customer rotation rate. Atomizing Spray also sprays water on the door, so you don't have to clean excess suds off the door glass.



Smarter

Management Web

Monitor your laundromat operations remotely with the LG management Web. You can get real-time status updates and diagnose problems remotely, allowing you to maximize productivity.



User App

LG Laundry Lounge App makes it easier than ever to do their laundry remotely, saving them precious time.

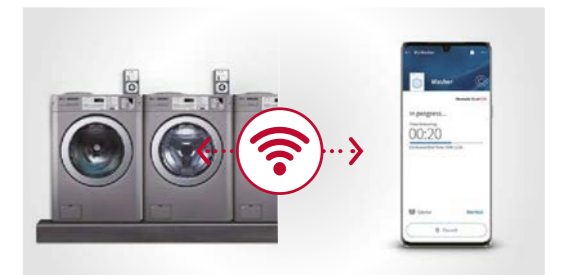

Industry Stories to Inspire Your Business

Take a look at various sites for your business.

Laundromats

The Perfect Set-up for Driving Profit. Optimized business support from planning to service.



On-Premise Laundry

Suitable for a wide range of businesses. Because it is powerful, durable and more over hygienic



Multi-Housing

Perfect Smart Solution for Multi-Housing. With a laundry alert system, there's no need to wait around for your laundry to finish. LG Smart Solutions make it possible from start to finish.



Design Your Business Space

Take your business to the next level with LG VR Simulator.



Exterior to Attract Customers

LG authorized signage and posters are available to maximize business visibility and to encourage customers to visit the laundromat.



Free Consulting through LG VR Simulator

The LG VR simulator defines the conditions and shapes of the space, and allows you to design the optimal laundromat layout. With 3D VR, you can envision your dream laundromat and even analyze your investment profitability.



GIANT-C MAX WASHER



		Non-Heater FH069FD*M*/GCWM1069*** /CWG27M**R*	Heater F*069FD*MS/CWG27M**H*
CYLINDER			
Drum Volume	cu.ft (℔)	3.7 (102.7)	3.7 (102.7)
Diameter	in. (mm)	22.1 (560)	22.1 (560)
Depth	in. (mm)	16.5 (419.3)	16.5 (419.3)
DIMENSIONS			
Product (WxHxD)	in mm	27 x 38.7 x 30.2 686 x 983 x 767	27 x 38.7 x 30.2 686 x 983 x 767
With Door Open	in. (mm)	50.8 (1,291)	50.8 (1,291)
Carton (WxHxD)	in mm	29.7 x 44.4 x 31.3 755 x 1,127 x 795	29.7 x 44.4 x 31.3 755 x 1,127 x 795
Weight (Product/Carton)	lb (kg)	191 (87) / 211 (96)	191 (87) / 211 (96)
SPEED⁰⁾			
Wash	RPM	40-50	40-50
Extract (Max RPM)	RPM	1,200	1,200
G-force	G	451	451
RATING⁰⁾			
Electric Ratings	V/Hz/A	100-120 / 50 or 60 / 4.2-5 (Heating 8.5-9.0) ¹⁾ 220-240 / 50 or 60 / 2.1-2.3 (Heating 8.4-9.6) ¹⁾	- 220-240 / 50 or 60 / 13.3-17.5
*CONSUMPTION INDEX⁰⁾²⁾			
Water	gal (l)	13.2 (50)	12 (45.5)
Electricity	kWh/cycle	100-120 / 0.5 (Heating 0.85-1.0) ¹⁾ 220-240 / 0.5(Heating 1.85-2.3) ¹⁾	3.6-3.8
NOISE & CYCLE TIME			
Noise Level (Sound Power)	dB	Lower than 62	Lower than 62
Program Duration in Minutes (Default) ⁰⁾	min	36	59 (60°C) Course ³⁾
SYSTEM & CONTROL			
Inverter Direct Drive Motor		0	0
Heating Element	V/W	100-120 / 1,000 ¹⁾ 220-240 / 2,000 ¹⁾	- 220-240 / 3,200
Drain System		BLDC Pump Drain	
Auto Dosing Interface		0	0
Gyro Sensor		0	0
Damper		4 Friction Dampers	4 Friction Dampers
PROGRAMS			
Program List		Hot or Hygiene (Short Key) ⁴⁾ *Pre-Clean (Long Key) ⁵⁾ Warm Cold Delicates Add Super Wash (Card & Coin)/ Custom PGM (OPL) Custom PGM (OPL)	90°C(194°F) 75°C(167°F) 60°C(140°F) 40°C(104°F) Cold(Short Key) *Custom PGM(Long Key) ⁶⁾
EXTERNAL FINISH			
Drum		Stainless Steel	Stainless Steel
CIRCUIT PROTECTION			
PCB Fuse - Main Control Board	amps	12 (220-240V)	12 (220-240V)
PCB Fuse- Filter Assembly	amps	15	15

*Dimensions and weights are approximate. *Design, features, and specifications subject to change without notice.
 *Some models may not be available for sale in certain countries. *Model name may vary by country
 0) This specification is different by countries. For the most accurate information, please refer to service manual.
 1) Only for Hygiene or tub clean cycle using heater.
 2) Without loading / Default water level(Non heater/Heater) : High/Mid / Non heating course
 3) Washer detects water temperature and adjusts heating time automatically if hot water supply is available
 4) If H4CS is dISb(disable), Hot cycle can be run. If H4CS is EnAb(enable), hygiene cycle can be run.
 5) When you press button for 3 seconds, Hot or Hygiene cycle will be changed to Pre-Clean cycle. (If ItCL is EnAb(enable), Pre-Clean cycle can be run.)
 6) When you press button for 3 seconds, Cold cycle will be changed to Custom PGM. (Cold for coin model, Custom PGM for OPL model)

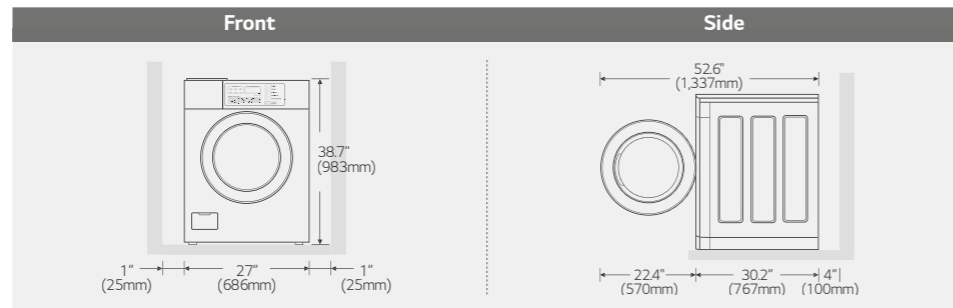



GIANT-C PRO DRYER



		Gas R*1329**** / GDL1329*G** / CDG27R****	Electric RV1329**** / GDV1329**E* / TD-V1329EA* / CDG27R**E*
CYLINDER			
Drum Volume	cu.ft (℔)	7.3 (207)	7.3 (207)
Diameter	in. (mm)	26.1 (663)	26.1 (663)
Depth	in. (mm)	22.5 (570.6)	22.5 (570.6)
DIMENSIONS			
Product (WxHxD)	in mm	27 x 38.7 x 30.1 686 x 983 x 764	27 x 38.7 x 30.1 686 x 983 x 764
With Door Open	in. (mm)	49.8 (1,264)	49.8 (1,264)
Carton (WxHxD)	in mm	29.9 x 46.14 x 31.3 760 x 1,170x 795	29.9 x 46.14 x 31.3 760 x 1,170x 795
Weight (Product/Carton)	lb (kg)	130 (59) / 143 (65)	130 (59) / 143 (65)
RATING⁰⁾			
Electric Ratings	V/Hz/A	120/60/5 220-240/50/2.4 220/60/3 -	120 (240)/60/26 220-240/50/22.5 220/60/21 240/50/19.5 ¹⁾
*CONSUMPTION INDEX PER CYCLE⁰⁾			
Gas	W	5.81	-
Electricity	W	0.35 (Max 0.7)	4.5-5.4
SYSTEM & CONTROL			
Heating Type		Gas (LNG/LPG) ²⁾	Electric
Type of Drying		Ventilation	Ventilation
Air Flow	CFM	160	160
Motor	kW	0.25	0.25
Gas Ratings ⁰⁾	kWh/BTU	5.8/20,000	-
Heating Element	kW	-	5.4
Program Duration in Minutes (Default) ⁰⁾	min	45 (NA) / 50 (EU) / 45 (Australia)	45 (NA)/50 (EU)/ 45 (Australia)
CONNECTIONS			
Air Outlet Diameter	in. (mm)	4 (100)	4 (100)
Exhaust Airflow Diameter	in. (mm)	4 (100)	4 (100)
PROGRAMS			
Program List		High Temp Med Temp Low Temp No Heat	High Temp Med Temp Low Temp No Heat
EXTERNAL FINISH			
Drum		Alcosta	Alcosta

*Dimensions and weights are approximate. *Design, features, and specifications subject to change without notice.
 *Some models may not be available for sale in certain countries. *Model name may vary by country
 0) This specification is different by countries. For the most accurate information, please refer to service manual.
 1) 4,500W for some countries due to power limitation (e.g. Australia).
 2) Gas type depends on country sales model.

Weather Hood Type	Number of 90° Elbows	Maximum length of 4" (10.2cm) diameter rigid metal duct	Maximum length of 4" (10.2cm) diameter flexible metal duct
Recommended	0	65 feet (19.8m)	45 feet (13.7m)
 4" (10.2cm)	1	55 feet (16.8m)	35 feet (10.7m)
	2	47 feet (14.3m)	30 feet (9.1m)
	3	36 feet (11.0m)	25 feet (7.6m)
 4" (10.2cm)	4	28 feet (8.5m)	20 feet (6.1m)
	0	55 feet (16.8m)	35 feet (10.7m)
	1	47 feet (14.3m)	27 feet (8.2m)
 2-1/2" (6.35cm)	2	41 feet (12.5m)	21 feet (6.4m)
	3	30 feet (9.1m)	17 feet (5.2m)
	4	22 feet (6.7m)	15 feet (4.5m)

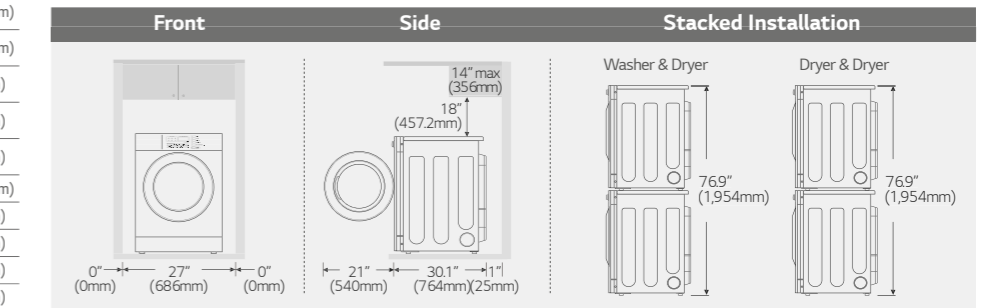

TITAN-C MAX WASHER



		Non-Heater FH0C7FD**M*/TCWM2013*** /CWT29M**R*	Heater FH0C7FD**MS/CWT29M**H*
CYLINDER			
Drum Volume	cu.ft (℔)	5.2 (147)	5.2 (147)
Diameter	in. (mm)	24 (610.8)	24 (610.8)
Depth	in. (mm)	20.4 (518.1)	20.4 (518.1)
DIMENSIONS			
Product (WxHxD)	in	29 x 40.8 x 32	29 x 40.8 x 32
	mm	737 x 1,036 x 814	737 x 1,036 x 814
With Door Open	in. (mm)	53 (1,370)	53 (1,370)
Carton (WxHxD)	in	31 x 44.3 x 33.3	31 x 44.3 x 33.3
	mm	788 x 1,125 x 846	788 x 1,125 x 846
Weight (Product/Carton)	lb (kg)	221.8 (100.6) / 248 (112.5)	221.8 (100.6) / 248 (112.5)
SPEED⁰⁾			
Wash	RPM	46	46
Extract (High Speed)	RPM	1,000	1,000
G-force	G	342	342
RATING⁰⁾			
Electric Ratings	V/Hz/A	100-120 / 50 or 60 / 4.2-5 (Heating 8.5-9.0) ¹⁾	-
		220-240 / 50 or 60 / 2.1-2.3 (Heating 9.1-10) ¹⁾	220-240 / 50 or 60 / 13.3-17.5
*CONSUMPTION INDEX⁰⁾²⁾			
Water	gal (l)	16.5 (62.5)	12.4 (47)
Electricity	V/kWh	100-120 / 0.5(Heating 0.85-1.0) ¹⁾ 220-240 / 0.5(Heating 2.0-2.4) ¹⁾	220-240 / 3.2-3.8
NOISE & CYCLE TIME			
Noise Level (Sound Power)	dB	Lower than 60	Lower than 60
Program Duration in Minutes (Default) ⁰⁾	min	36	59
SYSTEM & CONTROL			
Inverter Direct Drive Motor		O	O
Heating Element	V/W	100-120 / 1,000 ¹⁾ 220-240 / 2,000 ¹⁾	- 220-240 / 3200
Drain System		BLDC	BLDC
Emergency Stop Button		O (OPL Only)	O (OPL Only)
Auto Dosing Interface		O	O
Gyro Sensor		O	O
Damper		4 Friction Dampers	4 Friction Dampers
PROGRAMS⁰⁾			
Program List		Hot*	90°C
		Warm*	75°C
		Cold*	60°C
		Delicates*	40°C/30°C
		Add Super Wash (Card & Coin)/ 20 Custom PGM (OPL)	Cold * Custom PGM ³⁾
EXTERNAL FINISH			
Drum		Stainless Steel	Stainless Steel
CIRCUIT PROTECTION			
PCB Fuse - Main Control Board	amps	12 (220-240V)	12 (220-240V)
PCB Fuse- Filter Assembly	amps	15	15

*Dimensions and weights are approximate. *Design, features, and specifications subject to change without notice.

*Some models may not be available for sale in certain countries. *Model name may vary by country

*Energy Course available

0) This specification is different by countries. For the most accurate information, please refer to service manual.

1) Only for tub clean cycle using heater.

2) Based on DOE J2/J1 testing

3) When you press button for 3 seconds, Cold cycle will be changed to Custom PGM. (Cold for coin model, Custom PGM for OPL model)



TITAN-C LIGHT DRYER



		Gas CDT29M**** / R*1840***
CYLINDER		
Drum Volume	cu.ft (℔)	9.0 (254)
Diameter	in. (mm)	28.2 (716)
Depth	in. (mm)	24.2 (614)
DIMENSIONS		
Product (WxHxD)	in	29 x 40.2 x 31.9
	mm	737 x 1,022 x 810
With Door Open	in. (mm)	53.2 (1,350)
Carton (WxHxD)	in	30.7 x 33.3 x 45.1
	mm	788 x 845 x 45.1
Weight (Product/Carton)	lb (kg)	67.9 (149.6) / 75.8(167.1)
RATING⁰⁾		
Electric Ratings	V/Hz/A	220/60/5
CONSUMPTION INDEX (PER CYCLE)⁰⁾		
Electricity	kWh	0.35
SYSTEM & CONTROL		
Heating Type		Gas (LNG/LPG) ¹⁾
Type of Drying		Ventilation
Air Flow	CFM	210
Gas Ratings ⁰⁾	kWh/BTU	7.4 / 25,000
Motor	kWh	0.33
Program Duration in Minutes (Default) ⁰⁾	min	40
CONNECTIONS		
Air Outlet Diameter	in. (mm)	4 (100)
Exhaust Airflow Diameter	in. (mm)	4 (100)
PROGRAMS		
Program List		High Temp
		Med Temp
		Low Temp
		No Heat
EXTERNAL FINISH		
Drum		Stainless Steel

*Dimensions and weights are approximate. *Design, features, and specifications subject to change without notice.

*Some models may not be available for sale in certain countries. *Model name may vary by country

0) This specification is different by countries. For the most accurate information, please refer to service manual.

1) Gas type depends on country sales model.

Weather Hood Type	Number of 90° Elbows	Maximum length of 4" (10.2cm) diameter rigid metal duct	Maximum length of 4" (10.2cm) diameter flexible metal duct	
Recommended	0	65 feet (19.8m)	45 feet (13.7m)	
4" (10.2cm)	1	55 feet (16.8m)	35 feet (10.7m)	
	2	47 feet (14.3m)	30 feet (9.1m)	
	3	36 feet (11.0m)	25 feet (7.6m)	
4" (10.2cm)	4	28 feet (8.5m)	20 feet (6.1m)	
	Use Only for Short Run Installations	0	55 feet (16.8m)	35 feet (10.7m)
	1	47 feet (14.3m)	27 feet (8.2m)	
2-1/2" (6.35cm)	2	41 feet (12.5m)	21 feet (6.4m)	
	3	30 feet (9.1m)	17 feet (5.2m)	
	4	22 feet (6.7m)	15 feet (4.5m)	

